

Influences of External Store on Aerodynamic Performance of UTM-LST Generic Light Aircraft Model

Open
Access

Muhammad Zaki Abdul Manaf¹, Shabudin Mat^{1,*}, Shuhaimi Mansor¹, Mohd Nazri Nasir¹, Tholudin Mat Lazim¹, Wan Khairuddin Wan Ali¹, Wan Zaidi Wan Omar¹, Zurriati Mohd Ali², Ainullotfi Abdulatif¹, Mastura Abd Wahid¹, Md Nizam Dahalan¹, Norazila Othman¹

¹ Department of Aeronautical, Automotive and Ocean Engineering, Fakulti Kejuruteraan Mekanikal, Universiti Teknologi Malaysia, 81310 Skudai, Johor, Malaysia

² Faculty of Mechanical Engineering, Universiti Teknologi MARA Johor, Jalan Purnama, Bandar Seri Alam, 81750 Masai, Johor, Malaysia

ARTICLE INFO

ABSTRACT

Article history:

Received 5 June 2017

Received in revised form 4 October 2017

Accepted 1 December 2017

Available online 15 December 2017

This paper discusses the impact of the external store on the aerodynamic performance of the light aircraft model in the subsonic region. Light aircrafts are normally used to train pilots, survey, leisure and transportation. To date, there have been a lot of small aircrafts were used for a strategic purposes where an external store either external fuel storage or armament has been installed on its wing. Examples of such aircraft are KAI-KA1, A29 Super Tucano and Beechcraft AT-6. Therefore it is important to study the effect of this external store installation on the aerodynamic characteristics of a small aircraft. An available light aircraft model of UTM Low speed wind tunnel (UTM-LST) has been modified so that a generic external store can be mounted on the lower surface of the wing. Two set of experiments were carried out on the model which were; the experimental with the external store and followed by the experimental without external store as a benchmark of tested configuration. The experiments were conducted at 2 different speeds of 26 and 39 m / s that corresponding to 0.4×10^6 and 0.6×10^6 Reynolds numbers respectively. Three measurement techniques were employed on each configuration. The first measurement was the 6 component forces and moments measurement technique. The second technique was the pressure measurement on the wing while the final test was the tufts flow visualization. The result of steady balance indicates that external store has no effect on coefficient of lift at low attack angle but it shows that there was a reduction of lift coefficient by 2% at higher angle of attack. The data showed that the coefficient of drag increases by 4% when the external is installed. Suprisingly, the installation of store does not give significance effects on the pitching moment coefficient. An interesting feature is observed from surface pressure studies, the results obtained show that there is an increase in the pressure coefficient if the external is mounted on the wing at a low angle of attack, while this change does not occur at high attack angle.

Keywords:

Light aircraft, external store, wind tunnel testing, aerodynamic characteristics

Copyright © 2017 PENERBIT AKADEMIA BARU - All rights reserved

* Corresponding author.

E-mail address: shabudin@utm.my (Shabudin Mat)

1. Introduction

Light aircraft is defined as an aircraft that has maximum gross take-off weight of 5,670 kg or less. This type of aircrafts is widely use in aerial surveying, for training purposes, leisure and freight transport. However, due to light characteristics, cost-effective surveillance and easier to handle, there are manufacturers that converting light aircraft for combat mission, thus an external store is installed on its wing. The external store may comprise of external fuel store, missile or digital camera. The airflow through the light plane model is relatively complicated. Many papers discuss the flow through the wing of the light aircraft either by simulation or experiment. One of them was Kostic *et al.* [1]. They have performed numerical analysis to visualize the flow separation on the light aircraft wing at several angles of attack. This is shown in Figure 1 below. The images below shown the flow separation moved upstream from the trailing edge towards the leading if angle of attack is increased. Their results also showed that the growing of wake behind the plane when the angle of attack is increased.

Intensive wind tunnel testing on light aircraft model has been performed by Ocokoljic *et al.* [2] and Ristic *et al* [3]. The model has been tested in T-35 wind tunnel facility as shown in Fig. 2 below. They have discussed the results of the wind tunnel experiment compared to the results obtained from the computer simulation. They have suggested that it is necessary to use more method of investigations to get more reliable results for light aircraft aerodynamic characteristics.

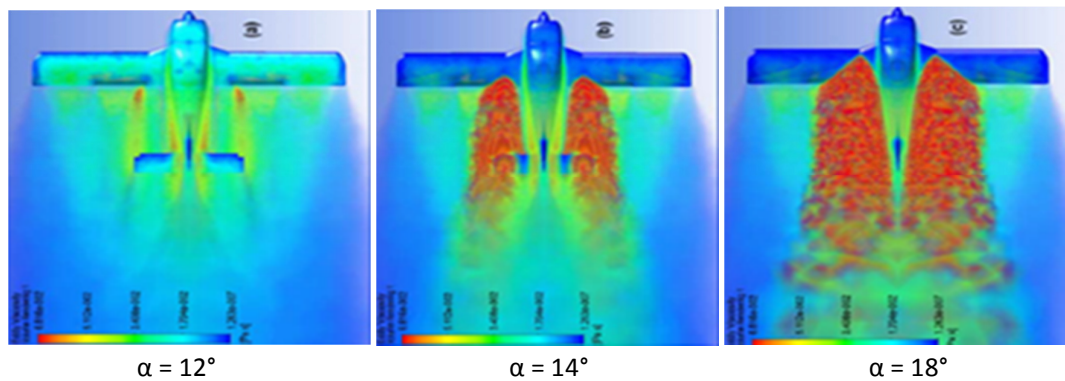

Fig. 1. The effects of flow separation at different angle of attacks, α [1]



Fig. 2. TAM mounted on the TEM support in the T-35 wind tunnel test section [2]

Similar light aircraft model is also available in UTM-LST wind tunnel facility. Several experiments on the model were performed in UTM- Low Speed Wind tunnel facility such as by Ishak *et al.* [4], Mansor [5], Bundu *et al.* [6], Mat [7] and Bundu *et al.* [8]. The wind tunnel has a test section of 2.0 m wide x 1.5 m height x 5.5 m length with a maximum speed of 82 m/s [5]. The main focuses on these projects were to determine the aerodynamics characteristics including the stability derivatives of UTM-LST light aircraft model. Bundu *et al.* [8] and Mat [7] had conducted several experiments to simulate the aircraft wing flow when the propeller is placed in front of the aircraft. The results have indicated that the increase in fan rotation has delayed the flow separation formed on the wing. All results obtained from experiments were systematically compared with CFD results for validation purposes and reliability [4].

The external store study on the lightweight subsonic fighter aircraft model in UTM has been initiated since 2004 [9,10] (Figure 3). In this project, the results obtained from experimental studies were compared with those from the numerical studies. The results conclude that installation of external storage on a subsonic aircraft wing has tremendously affected pressure distribution especially on the lower surface of the wing.

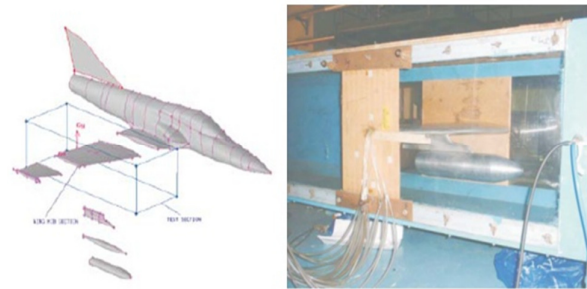

Fig. 3. A subsonic fighter aircraft wing been tested in wind tunnel testing with external store installed on its wing [9,10].

According to Mouton *et al.* [11] who performed numerical and experimental studies on the nacelles, the external store (nacelles) have indeed a very significant impact on drag and very little effect on lift and stability. The results obtained not consistent Yang [12] who numerically shows the external store has effected the flow on the mother aircraft. The store also can cause several longitudinal stability effects. Later work by Yang [13] have shown that the relative distance of the mother aircraft and store has influenced the lift coefficient curve slope and pitching moment curve slope significantly.

From a brief literature review above, we can see that there has no experiment to study the effect of external store on the aerodynamic performance of UTM LST light aircraft model. A research grant was obtained to investigate the effect of the external store on the aerodynamic characteristics of this model. In this project, UTM LST light aircraft wind tunnel model has been modified and tested in order to investigate the store effects on the aerodynamic characteristics of this model.

2. External Store Design

The CAD drawing for the external store, mother aircraft and its installation in UTM-LST is shown in Fig. 4. The external store has been positioned at about 17 and 31 % from the model centre line. The final dimensions of the external store are it has an overall length of 209 mm with a diameter of

40 mm. It has been manufactured using aluminum. The model has been attached to 6 axis forces and moments external balance system located underneath the test section through 3 strut supports. The model angle of attack, α can be obtained by adjusting the rear struts vertically.

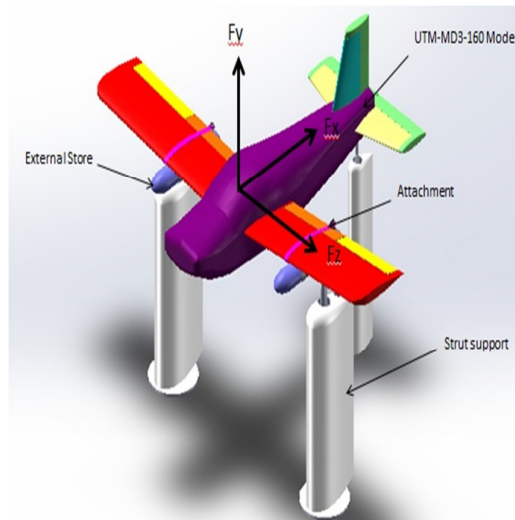

Fig. 4. CAD model of UTM-LST with external store

3. Wind Tunnel Testing

There were two main parts of the experiment performed on this project, i.e; the first experiment was the experiment without the external store namely clean wing configuration and followed with external store experiment. The experiments were conducted in 2.0m (width) x 1.5m (height) x 5.8m (long), closed-circuit UTM. The experiments were conducted at speeds of 26 m/s and 39 m/s that equivalent to 0.5×10^6 and 1.0×10^6 respectively based on mean aerodynamic chord of the wing. The solid and wake blockage calculation and standard testing procedures discussed by Pope [14, 15] and have been followed in conducting experiments and data analysis.

3.1 Clean Configuration Experiments

The final installation of the light aircraft model inside the test section for clean wing configuration is shown in Fig. 5. The model is attached to 3 strut support structure which connected to heavy capacity 6 axis external balances located underneath the test section. The experiments were performed at 2 speeds of 26 and 39 m/s that corresponding to 0.4 and 0.6×10^6 of Reynolds number respectively. The model angle of attacks, α were automatically altered varied from 0° to 25° degrees.

3.2 External Store Experiments

The installation of the model for external store experiments is shown in Fig. 6. The external was fixed at 2 different positions on the lower surface of the wing. The first position was at about 23 cm (31%) from the wing centre line while another position was at 13 cm (17%) from the wing centre line as shown in figure 6. The experiments were also performed at similar speeds of 26 and 39 m/s that corresponding to 0.4×10^6 and 0.6×10^6 of Reynolds number based on mean aerodynamic

chord respectively. The forces and moments in x, y and z axes plus the surface pressures at 40 cm from the wing centre line were logged simultaneously.



Fig. 5. Installation of UTM-LST light for clean wing configurations

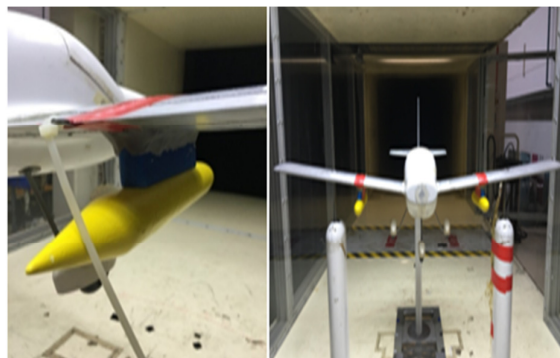

Fig. 6. The installation of UTM-LST light aircraft model with external store in UTM-LST

4. Results and Discussions

4.1 Steady Balance Data

Figures 7, 8 and 9 show the results obtained from steady balance data, *i.e* coefficients of lift (CL), drag (CD) and pitching moment (CM) measured at wing reference chord line. The solid and wake blockage corrections have been considered based on Pope [14] and reference [15]. To compare the effects of the Reynolds number, each coefficient has been plotted at velocities of 26 m/s and 39 m/s. In the figures, the blue dotted line is for the clean wing configuration, the red dotted line is for the model with the storage attached at 23 cm and the green dotted line is for the model with the storage attached at 13 cm from the wing center line.

At 26 m/s free stream velocity is shown in Fig. 7. It can be observed that the coefficient of lift changes only slightly for the entire angle of attack range from $\alpha = 0^\circ$ to 23° . At higher velocities of it is observed that the lift coefficient does not change much at α lower than 7° whereas at angles

higher than 7° , the external store affected a general reduction in the coefficient of lift (Fig. 7 (ii)). The alpha stall angle also decreases in this condition. This situation happens because the steady laminar flow has been interrupted by the installation of the external store. Another important observation is that the external store position from the wing center line does not affect the overall lift force production.

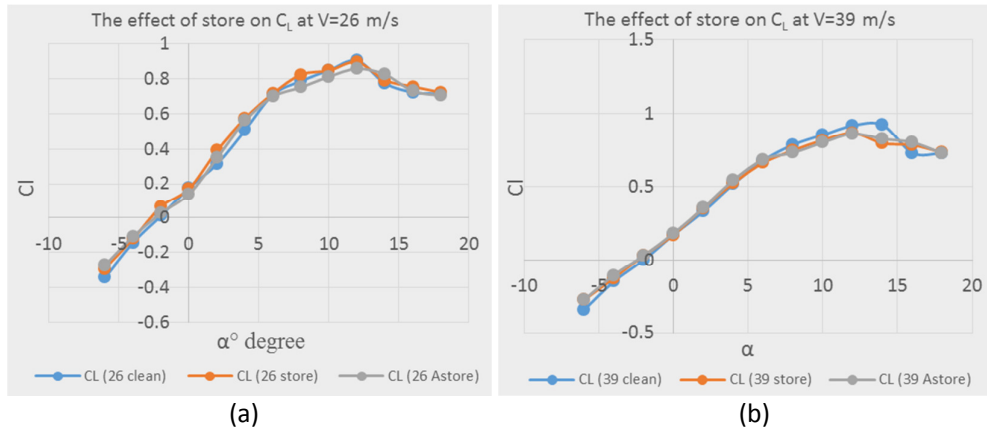

Fig. 7. Effects of store on lift coefficient at (a) $V = 26\text{m/s}$ and (b) $V = 39\text{ m/s}$

The coefficient of drag obtained from this experiment is shown in Fig. 8. The results at two velocities indicated that the installation of the external store has increased the drag coefficient. The drag is increased mainly due to the installation of external store which also increased the frontal area for overall aircraft towards the incoming flow. Secondary reasons for the increase in drag are the shape of the frontal outline, the induced drag of the stores, and the interference drag of the store and the aircraft.

At the speed of 26 m/s and corresponding to the Reynolds number of 0.4×10^6 , it is noted that the drag coefficient obtained is higher when the external store is mounted at 13 mm from the wing center line compared to the drag than the clean wing configuration. This finding occurs because when the external store is installed near the fuselage, the wake generated by the external store joined the wake generated by the fuselage and thus creating a bigger wake behind the aircraft, resulting in higher total drag. This situation is also can be observed at the higher speed of 39 m/s (Reynolds number of 0.6×10^6).

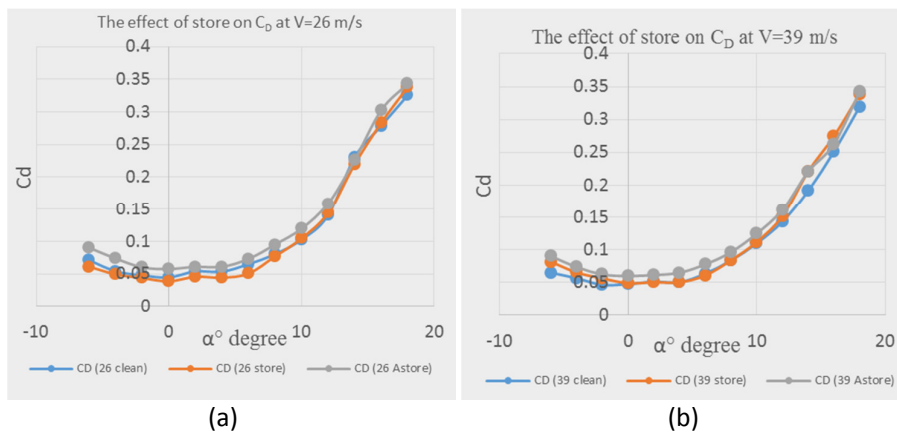

Fig. 8. Effects of stores on drag coefficient at (a) $V = 26\text{ m/s}$ and (b) $V = 39\text{ m/s}$

The pitching moment results from external balance are shown in Fig. 9. The figures show that the installation of external stores does not affect the pitching moment coefficient. The negative slope indicates that the aircraft is longitudinally stable. The results are consistent with Kostic [1] and Goran [2]. It should be noted here that the pitching moment have a positive intercept, that is, $C_{m0} > 0$ to trim at positive angles of attack.

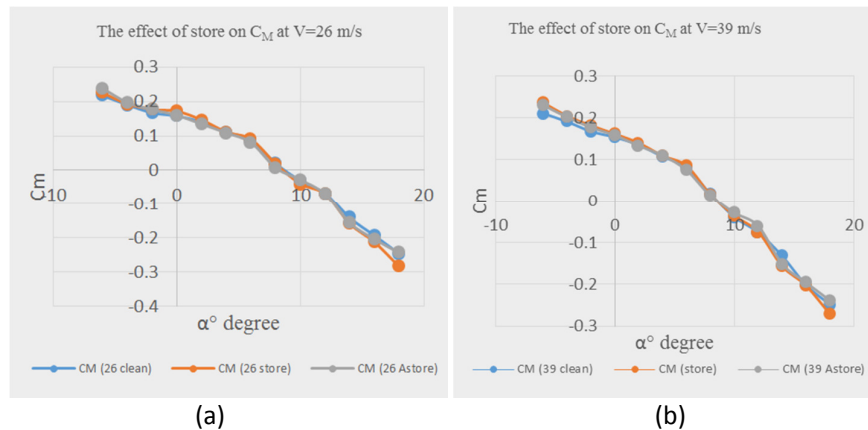

Fig. 9. Effects of stores on pitching moment coefficient at (a) $V = 26$ m/s and (b) $V = 39$ m/s

4.2 Surface pressure measurement at low angle of attack

This section discusses the results obtained from the surface pressure experiments performed on the model. There are 21 pressure taps to measure the pressures located at a distance of 30 cm from the wing centre line. (14 on the upper surface and 7 on the lower surface). Fig. 10 shows the results obtained at the lower angle of attack *i.e* at $\alpha = -4^\circ$ (Fig. 10 (a)), $\alpha = -4^\circ$ (Fig. 10(b)) and $\alpha = 2^\circ$ (Fig. 10 (c)). It should be noted here that the 2nd configuration is for the store at 23 cm and the 3rd configuration is for the store at 13 cm from the wing center line

For the upper surface, at low angle of attack ($\alpha = -4^\circ$) the external store has increased the pressure coefficients at the trailing edge (Fig. 10i). It can also be seen in the figure that the external store position also tremendously affects the pressure coefficient. In this case, when the external store is installed near the fuselage, the pressure coefficient increase was higher. The same situation can be observed when α is increased to 0° , it can be noted that the pressure coefficient is still high when the external store is installed. When attack of angle is increased to $\alpha = 2^\circ$, it could be seen that this external store had affected the airflow behaviour from the leading edge to 30% of the wing chord. Beyond this position, the external store has no aerodynamics effect on the flow. The result obtained here is inconsistent with Mat Lazim [9] who showed that the flow on the upper surface is not affected by the external store. The results also show that the increase in Reynolds number from 0.4×10^6 to 0.6×10^6 has no effect on the flow.

On the lower surface, the effect of external store installation can be observed at $\alpha = 2^\circ$, in this case the location of the external store has effecting the pressure distribution in chord wise direction. When the external store is mounted near the fuselage, it is notable that the pressure coefficient is comparatively low. This indicates that the wake generated by the external store has joined the wake generated by fuselage and this reduces the coefficient of pressure significantly. When the angle of attack is increased from $\alpha = -4^\circ$ to $\alpha = 2^\circ$, the external store effect reduces. This results consistent with Mat Lazim [9] who experimentally and numerically showed that the external store has affecting pressure coefficient at lower angle of attack.

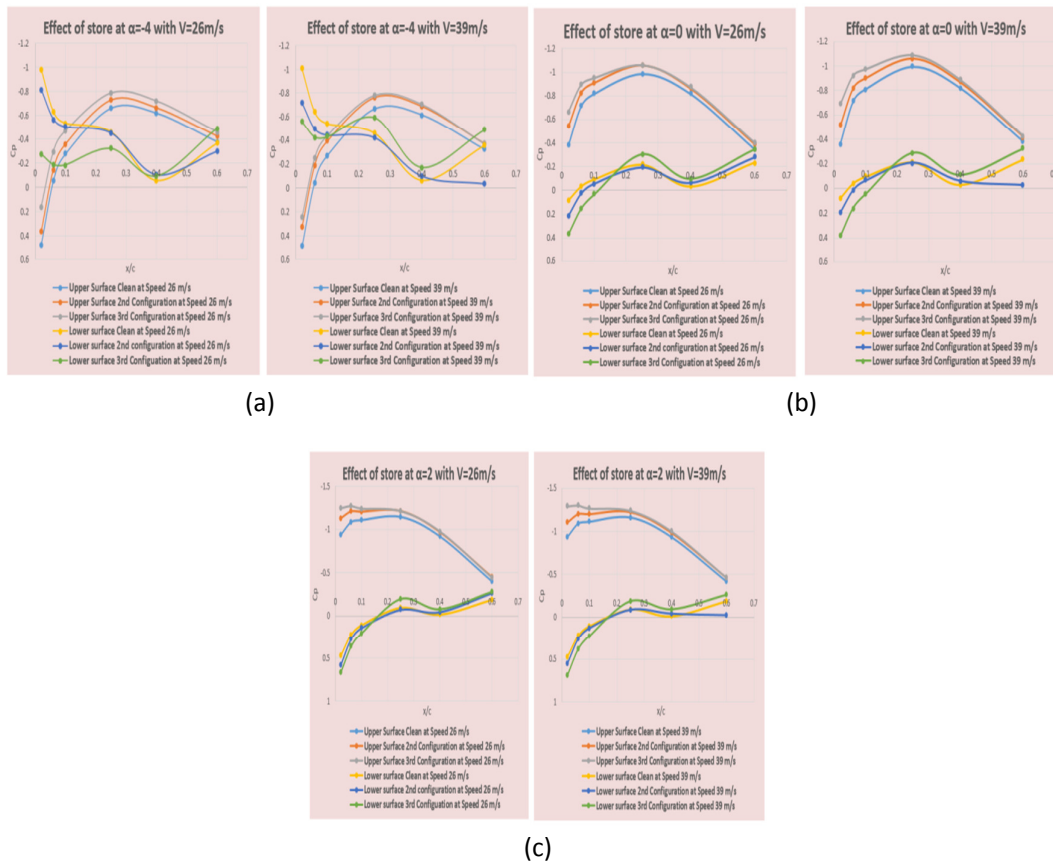

Fig. 10. Effects of store on pressure coefficient at lower angle of attack, (a) $\alpha = -4^\circ$ (b) $\alpha = 0^\circ$ and (c) $\alpha = 2^\circ$

4.3 High Angle of Attack (from $\alpha = 8^\circ$ to $\alpha = 12^\circ$)

The results obtained at the higher angle of attack $\alpha = 8^\circ$, 12° and 16° are shown in Fig. 11. The results showed that flow separation shift upwards to the leading edge when the angle of attack is increased regardless the position of the external store. The results obtained also showed that the external store does not affecting the flow characteristics at higher angle of attack. The increased in Reynolds number from 0.4×10^6 to 0.6×10^6 also has insignificant on pressure coefficients. At $\alpha = 8^\circ$, flow separation covers 80% of the wing. When the angle of attack is increased to $\alpha = 12^\circ$, flow separation covers 90% of the wing. Finally, the whole wing is covered by the flow separation when the attack angle is increased to $\alpha = 16^\circ$.

4.4 Flow Visualization

The final experiment performed on the model was the tuft studies. The images of the tuft during the experiments were capture using high resolution digital camera in order to observe the flow separation above the wing and the location where the external store is mounted. The simple images at the speeds of 39 m/s are shown in Fig. 12. The angle of attack were varied from $\alpha = 0^\circ$ to $\alpha = 18^\circ$. On the upper surface of the wing, it is notable that the flow is attached to the wing surface at $\alpha = 0^\circ$. When the angle of attack is increased to $\alpha = 10^\circ$ the flow began to separate particularly near the trailing edge and eventually moved towards the leading edge. At $\alpha = 16^\circ$ and above, the entire wing is completely covered by the separation flow. The results obtained here are consistent with Bundu [6] and Mat [7]. However, this flow technique is not able to observe the flow separation

on the lower surface particularly in the region where the external store is mounted. More experiments with appropriate photography techniques need to be done to observe the flow on the lower surface.

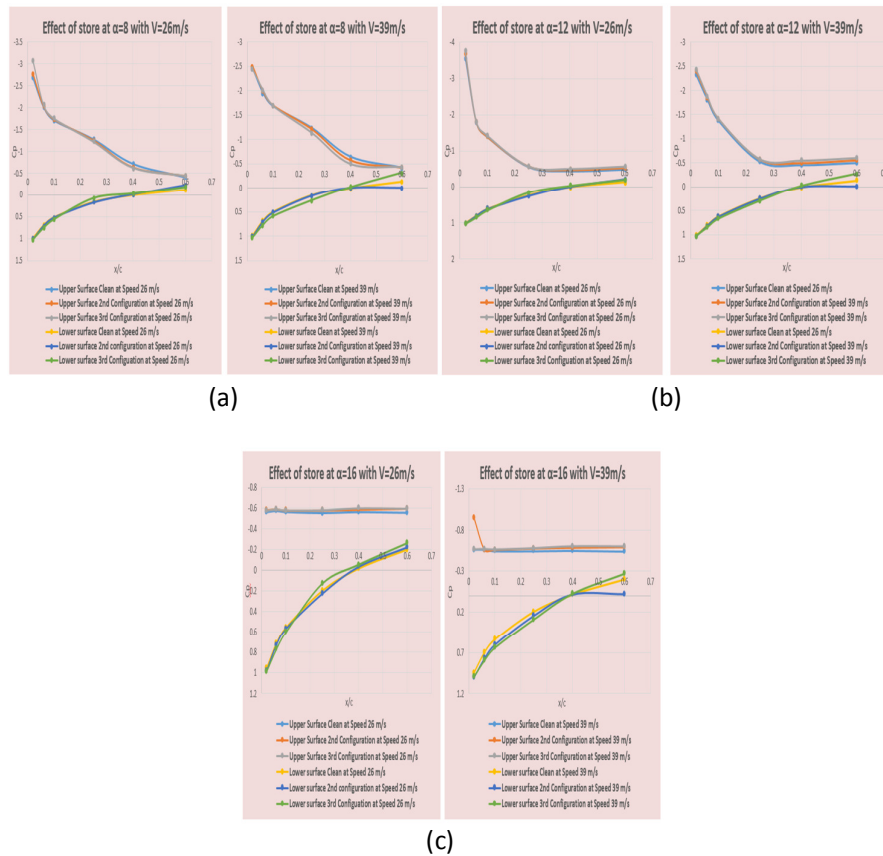

Fig. 11. Effects of store on pressure coefficient at higher angle of attack, (a) $\alpha = 8^\circ$ (b) $\alpha = 12^\circ$ and (c) $\alpha = 16^\circ$

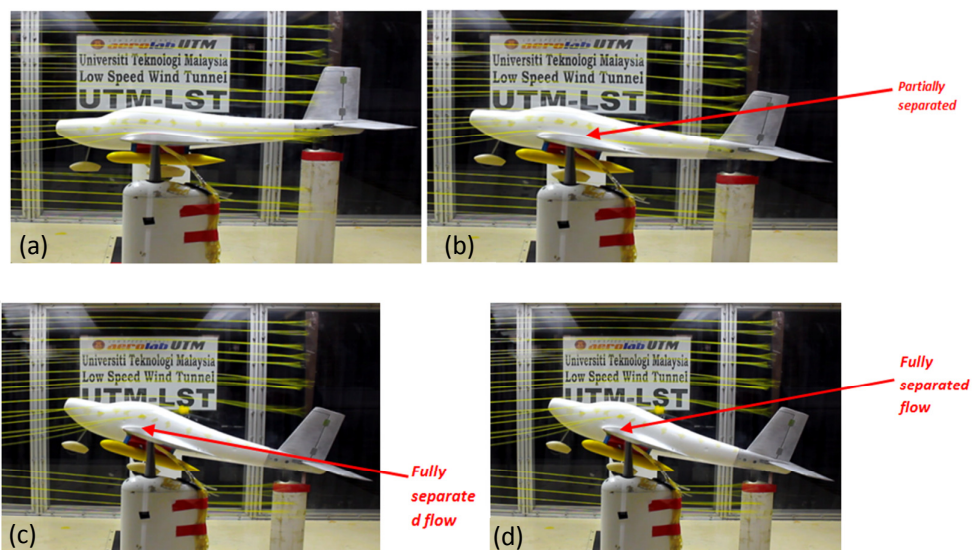

Fig. 12. Flow tuft experiment at various angles of attack, (a) $\alpha = 0^\circ$, (b) $\alpha = 10^\circ$, (c) $\alpha = 16^\circ$ and (d) $\alpha = 18^\circ$

5. Conclusion

A light aircraft model has been tested in the UTM LST facility. The main purpose of this project was to study the influences of the external store on the aerodynamics performance of light aircraft model. The model has been tested at the speeds of 26 m/s and 39 m/s that corresponding to Reynolds numbers of 0.4×10^6 and 0.6×10^6 respectively. Three established measurement tools were employed on the model, *i.e* steady balance, surface pressure measurement and tuft flow visualization study techniques. An important observation of this study is that external has reduced the lift and increased drag. The lift is reduced because the flow has been interrupt by the installation of the external store. The drag is reduced because the wake generated by the external store has joined the wake generated by the fuselage a creating a bigger wake behind the model. An important observation to be noted is that the external store position from the wing center line does not affect the lift but the drag force production. In addition the results obtained here also showed that the external store has not affecting the pitching moment characteristics. The data also described that the external store position has affecting the pressure coefficient particularly at low angle of attack. More experiments are planned in the near future to observe the flow separation on the lower surface of the wing.

Acknowledgements

This research was funded by a grant from Ministry of Higher Education of Malaysia and Universiti Teknologi Malaysia (FRGS Grant R.J130000.7824.4F718& 4F172). The data presented, the statement made, and views expressed are solely the responsibility of the authors.

References

- [1] Kostić, Ivan A., Zoran A. Stefanović, and Olivera P. Kostić. "Aerodynamic analysis of a light aircraft at different design stages." *FME Transactions* 42, no. 2 (2014): 94-105.
- [2] Ocokoljić, Goran, Boško Rašuo, and Mirko Kozić. "Supporting system interference on aerodynamic characteristics of an aircraft model in a low-speed wind tunnel." *Aerospace Science and Technology* 64 (2017): 133-146.
- [3] Ristić, Slavica, Aekсандar Vitić, Zoran Anastasijević, and Đorđe Vuković. "Investigation of model support influence upon aerodynamic characteristics of a torpedo model in the T-38 wind tunnel." *Scientific Technical Review* 54, no. 1 (2004): 50-57.
- [4] Ishak, Iskandar Shah, Shabudin Mat, Tholudin Mat Lazim, Mohd Khir Muhammad, Shuhaimi Mansor, and Mohd Zailani Awang. "Estimation of Aerodynamic Characteristics of a Light Aircraft." *Jurnal Mekanikal* 22 (2006): 64-74.
- [5] S. Mansor. (2008). Low Speed Wind Tunnel Universiti Teknologi Malaysia.
- [6] A. I. Bundu, S. Mat and I. S. Ishak, (2015). Effect of Control Surface and Reynolds number on flow separation of Generic Light Aircraft. Proceeding of Ocean, Mechanical and Aerospace -Science and Engineering. (1-6).
- [7] S. Mat, A. I. Bundu, N. I. Zulkefli, and I. S. Ishak, (2016). Wind Tunnel Testing For Light Aircraft Model. Aeronautical Engineering Research at UTM. Penerbit UTM Press.
- [8] A. I. Bundu, (2017). Experimental Investigation on A Generic Light Aircraft With Rotating Propeller at Low Reynolds number, Master thesis, Faculty of Mechanical Engineering, Universiti Teknologi Malaysia.
- [9] Lazim, Tholudin Mat, Shabudin Mat, and Huong Yu Saint. "Computational Fluid Dynamic Simulation (CFD) and Experimental Study on Wing-external Store Aerodynamic Interference of a Subsonic Fighter Aircraft." *Acta Polytechnica* 43, no. 5 (2003).
- [10] T. Mat Lazim, Y. S. Houg, S. Mat, A CFD and Experimental Study on Wing External Store Aerodynamic Interference of a Subsonic Fighter Aircraft, 3rd International Conference on Advance Engineering Design, 1-4 June 2003, Prague, Czech Republic.
- [11] S. Mouton, E. Rantet, G. Gouverneur, & C. Verbeke, (2012). Combined Wind Tunnel Test and Flow Simulations for Light Aircraft Performance Prediction. International Symposium of Applied Aerodynamics.
- [12] Yang, Shih-Ying, Wei-Ting Liao, and Qing-Hao Chen. "Turbulent Study of Roll Pitch Yaw Phenomena for a Finned Store Released from a Wing Regarding Different Values of Angle of Attack." *Procedia Engineering* 79 (2014): 86-93.

- [13] Yang, Lei, Zheng-Yin Ye, and Jie Wu. "The influence of the elastic vibration of the carrier to the aerodynamics of the external store in air-launch-to-orbit process." *Acta Astronautica* 128 (2016): 440-454.
- [14] A. Pope, *Wind Tunnel Testing*, Experimental Aerodynamics Division, Sandia Corporation, JohnWiley and Sons, Inc., London, 1947.
- [15] *AIAA Recommended Practice for Wind Tunnel Testing – Part 1(2)*, R-092-1(2)-2003e, AIAA Standards, 2003.